



**Johnson
Screens**

A brand of
Aqseptence Group

Stainless Steel Water Well Screens and Accessories

Johnson Screens is one of the largest manufacturers of stainless steel water well screens in the world. With a high open area, allowing for better access to the entire formation around the screen; fines and drilling fluid are removed quickly and completely, resulting in a better well development.



Technical support and design assistance

- Sand analysis of formation materials
- Screen size recommendations
- Screen installation suggestions
- Well construction consultation

Technical staff includes: design engineers, welders, technical support personnel and sales engineers who have been on the factory floor, presented in classrooms and technical seminars, set and pulled screens and run pumping test.

Less Maintenance

The continuous Vee-Wire® slot design allows for lower entrance velocity of the water, reducing encrustation rates. The slot design also resists plugging and prevents sand from damaging pumps.

Pumping Costs

The high open area of the Vee-Wire well screen allows for water to enter the well freely, resulting in minimal drawdown and less energy usage by a pump.

Optimal Performance Through

- Screens designed to site-specific yield requirements and aquifer characteristics
- Screen slot opening selected from formation sand sample analysis
- Wire and rod construction to deliver required strength for the specified well depth
- Stainless material selected to maximize corrosion resistance for water chemistry
- Wide variety of fittings to facilitate secure and efficient installation

Sand Control

The water well screen is a key component of the sand control system, either as an integral component of the gravel pack, or as a standalone provider of sand control. Patented Vee-Wire technology and welded construction, help to prevent well screen failure by better controlling the sand.

Water Well Drive Points

60 wire models - 304 and 316 Stainless Steel

Size (in.)	OD (in.)	ID (in.)	Screen Weight ¹ (lbs./ft.)	Max Depth (ft.)	Tensile Strength ² (lbs.)	Column Strength ³ (lbs.)
1.25	1.7	1.0	2.0	1,000	5,500	5,800
2P	2.4	1.7	2.7	1,000	7,200	8,700
2P Sand Point	2.6	2.0	2.5	1,000	4,900	4,200
3P All Drive	3.7	3.0	4.4	1,000	12,700	13,400
4P All Drive	4.7	4.0	5.6	600	16,300	21,400
4P - Double Drive	4.8	4.0	7.0	1,000	16,300	21,400

Size (in.)	Open Area - sq in./ft. of Screen						Collapse Strength - PSI ⁴					
	Screen Slot Size - (thousandths of an in.)						Screen Slot Size - (thousandths of an in.)					
	6	10	12	15	20	30	6	10	12	15	20	30
1.25	5.8	9.1	10.6	12.7	15.9	21.2	6,155	5,804	5,642	5,417	5,078	4,514
2P	8.2	12.8	15.0	17.9	22.4	29.9	2,349	2,215	2,153	2,067	1,938	1,722
2P Sand Point	8.9	14.0	16.3	19.6	24.5	32.6	1,825	1,721	1,673	1,606	1,506	1,338
3P All Drive	12.6	19.7	23.0	27.6	34.5	46.1	638	620	603	579	543	483
4P All Drive	16.0	25.2	29.4	35.3	44.1	58.8	318	300	291	280	262	233
4P - Double Drive	11.3	18.1	21.3	25.9	32.9	45.2	835	801	785	763	728	667

90 Wire Models - 304 and 316 Stainless Steel

Size (in.)	OD (in.)	ID (in.)	Screen Weight ¹ (lbs./ft.)	Max Depth (ft.)	Tensile Strength ² (lbs.)	Column Strength ³ (lbs.)
1.25	1.7	1.0	1.7	600	5,500	5,800
2P	2.4	1.7	2.3	600	7,200	8,700
2P Sand Point	2.6	2.0	2.0	600	4,900	4,200
4P All Drive	4.6	4.0	4.8	250	16,300	21,400

Size (in.)	Open Area - sq in./ft. of Screen						Collapse Strength - PSI ⁴					
	Screen Slot Size (thousandths of an in.)						Screen Slot Size (thousandths of an in.)					
	6	10	12	15	20	30	6	10	12	15	20	30
1.25	4.0	6.4	7.6	9.2	11.7	16.1	2,496	2,396	2,348	2,280	2,176	1,993
2P	5.7	9.1	10.7	12.9	16.5	22.6	857	822	806	782	747	684
2P Sand Point	5.9	9.5	11.1	13.5	17.2	23.7	743	713	699	679	648	594
4P All Drive	11.0	17.6	20.7	25.2	32.0	44.0	118	113	111	108	103	94

- Transmitting capacity (gpm/ft. of screen) = open area x 0.31 @ 0.1 ft./sec
 - P - pipe size



Drive Point

1. Weight is based on 10 slot construction, no fittings
2. Tensile and column strengths include a 30 percent safety factor
3. Column strength is based on 5 ft. screen barrel length
4. Calculated collapse values - no safety factor included

End Fitting and Screen Connection Options

The majority of well screen installations involve at least a few standard fitting combinations.

Telescope size screens typically use a Figure K packer on the screen top and a welded or threaded plate bottom. Pipe size screens attach directly to the casing and usually have plate bottoms.

Johnson Screens has several fittings and accessories, such as centralizers, shale traps and connecting fittings for quick delivery.

Options include:

- Flush threads (Sch. 40 and Sch. 80)
- NPT threads
- Weld rings
- API couplers
- Plate bottom
- Threaded point
- Threaded cap/plugs
- Locking caps
- Bail hooks
- Weld ring x weld ring
- Weld ring x collar
- PVC to stainless steel adapter
- Quickloc®
- Shur-A-Lock®
- ShurGrip®

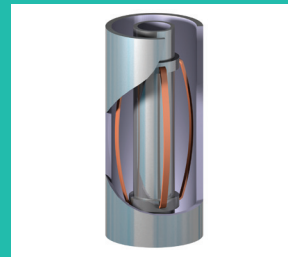

Centralizer



Figure TF Washdown



JSL Fittings

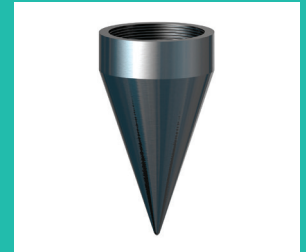

Drive Point



Back Pressure Valves

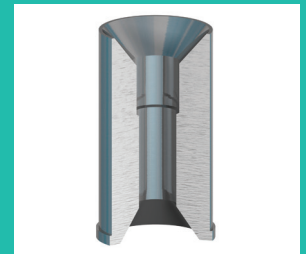

Wash Plugs



Shale Trap



Figure K Packer

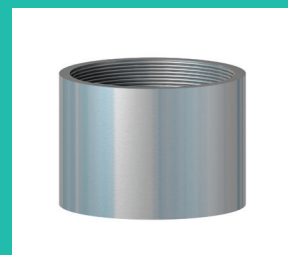

R & L Threaded Couplings



R & L Threaded Nipples

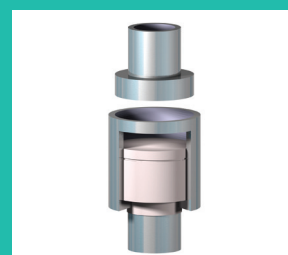

Di-Electric Coupling

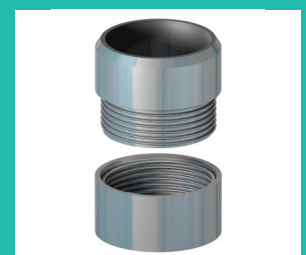

Flush Thread

Small Diameter Stainless Steel Well Screens

Water Well and Environmental Screens 60 Wire Construction 304 and 316 Stainless Steel

Size (in.)	OD (in.)	ID (in.)	Screen Weight ¹ (lbs./ft.)	Max Depth (ft.)	Tensile Strength ² (lbs.)	Recom. Hang Weight ³ (lbs.)	Column Strength ⁴ (lbs.)
1.25	1.7	1.1	1.8	1,000	4,200	2,100	3,100
2P*	2.5	1.99**	1.9	1,000	2,000	1,000	1,500
2P/3T	2.6	2.0	2.2	1,000	3,400	1,700	2,600
2.5P	3.0	2.4	2.6	1,000	4,200	2,100	3,100
3P*	3.6	2.9	2.9	1,000	4,200	2,100	3,100
3P/4T	3.7	3.1	3.0	1,000	4,200	2,100	3,100
4P*	4.6	4.0**	3.7	600	4,800	2,400	3,700
4P/5T	4.7	4.1	3.8	600	4,800	2,400	3,700
5P/6T	5.6	5.0	4.5	400	5,600	2,800	4,200

Size (in.)	Open Area - sq. in./ft. of Screen							Collapse Strength ⁵ - PSI						
	Screen Slot Size (thousandths of an in.)							Screen Slot Size (thousandths of an in.)						
	7	10	12	20	30	40	50	7	10	12	20	30	40	50
1.25	6.9	9.4	10.9	16.4	21.9	26.2	29.8	5,901	5,648	5,491	4,942	4,393	3,954	3,594
2P*	9.7	13.3	15.5	23.3	31.0	37.2	42.3	2,094	2,004	1,948	1,754	1,559	1,403	1,275
2P/3T	10.1	13.8	16.1	24.1	32.2	38.6	43.9	1,883	1,802	1,752	1,577	1,402	1,262	1,147
2.5P	11.9	16.2	18.9	28.4	37.8	45.4	51.6	1,164	1,114	1,083	975	867	780	709
3P*	14.0	19.1	22.3	33.5	44.6	53.5	60.8	713	682	663	597	531	478	434
3P/4T	14.5	19.9	23.2	34.8	46.4	55.6	63.2	635	608	591	532	473	426	387
4P*	17.9	24.5	28.6	42.9	57.2	68.6	78.0	340	326	317	285	253	228	207
4P/5T	18.6	25.4	29.6	44.4	59.2	71.0	80.7	307	294	286	257	229	206	187
5P/6T	22.1	30.2	35.2	52.9	70.5	84.6	96.1	182	174	170	153	136	122	111

* Alternate constructions for water well and environmental

** ID confirmed clear for environmental with Sch. 40 fittings only (Sch. 80 is smaller)

1. Weight is based on 10 slot construction, no fittings
2. Tensile and column strengths include a 30 percent safety factor
3. Recommended hang weight is 50 percent of calculated tensile strength
4. Column strength is based on 5 ft. screen barrel length
5. Calculated collapse values - no safety factor included

Notes:

- Transmitting capacity (gpm/ft. of screen) = open area x 0.31 @ 0.1 ft./sec
- P - pipe size, T - telescope



Water Well and Environmental Screens 90 Wire Construction 304 and 316

Size (in.)	OD: (in.)	ID: (in.)	Screen Weight ¹ (lbs/ft.)	Max Depth (ft.)	Tensile Strength ² (lbs.)	Recom. Hang Weight ³ (lbs.)	Column Strength ⁴ (lbs.)
1.25	1.7	1.1	1.5	600	4,200	2,100	3,100
2P*	2.4	1.99**	1.5	600	2,000	1,000	1,500
2P/3T	2.5	2.0	1.7	600	3,400	1,700	2,600
2.5P	3.0	2.4	2.1	600	4,200	2,100	3,100
3P*	3.5	2.9	2.3	600	4,200	2,100	3,100
3P/4T	3.7	3.1	2.4	600	4,200	2,100	3,100
4P*	4.5	4.0**	2.9	250	4,800	2,400	3,700
4P/5T	4.7	4.1	3.0	250	4,800	2,400	3,700
5P/6T	5.6	5.0	3.5	100	5,600	2,800	4,200

Size (in.)	Open Area - sq in./ft. of Screen							Collapse Strength ⁵ - PSI						
	Screen Slot Size (thousandths of an in.)							Screen Slot Size (thousandths of an in.)						
	7	10	12	20	30	40	50	7	10	12	20	30	40	50
1.25	4.6	6.4	7.6	11.7	16.1	19.8	22.1	2,343	2,272	2,227	2,063	1,890	1,743	1,618
2P*	6.6	9.2	10.8	16.7	22.9	28.2	32.7	817	792	776	719	659	608	564
2P/3T	6.9	9.6	11.2	17.4	23.9	29.3	34.0	724	702	688	637	585	538	500
2.5P	8.1	11.3	13.3	20.5	28.1	34.6	40.1	443	429	421	390	357	330	306
3P*	9.6	13.3	15.7	24.2	33.3	40.9	47.5	269	261	255	237	217	200	186
3P/4T	10.0	13.9	16.3	25.2	34.6	42.6	49.4	239	232	227	211	193	178	165
4P*	12.4	17.1	20.2	31.1	42.8	52.6	61.0	127	123	121	112	102	94	88
4P/5T	12.8	17.7	20.9	32.2	44.3	54.5	63.2	114	111	109	101	92	85	79
5P/6T	15.3	21.2	24.9	38.5	52.8	65.0	75.4	67	65	64	59	54	50	47

* Alternate constructions for water well and environmental

** ID confirmed clear for environmental with Sch. 40 fittings only (Sch. 80 is smaller)

1. Weight is based on 10 slot construction, no fittings
2. Tensile and column strengths include a 30 percent safety factor
3. Recommended hang weight is 50 percent of calculated tensile strength
4. Column strength is based on 5 ft. screen barrel length
5. Calculated collapse values - no safety factor included

Notes:

- Transmitting capacity (gpm/ft. of screen) = open area x 0.31 @ 0.1 ft./sec
- P - pipe size, T - telescope



Free-Flow 304 Stainless Steel Screens

Large Diameter Free-Flow Screens: Sizes 6P - 16T

Size (in.)	Max Depth (ft.)	OD: (in.)	ID (in.)	Weight ¹ (lbs./ft.)	Recom. Hang Weight ² (lbs.)	Collapse Strength ¹ (PSI)	Intake Area ³ - sq. in./ft. of Screen							
							Screen Slot Size (thousandths of an in.)							
							10	20	30	40	50	60	80	100
6P	100	6.6	6.1	4.5	4,315	83	36	62	83	100	113	124	142	156
	250	6.7	6.1	4.8	4,315	187	20	37	52	65	76	86	103	117
	600	6.7	5.9	6.0	8,813	185	20	37	52	65	76	86	103	117
	1,000	6.8	5.9	9.0	10,987	681	16	30	43	54	64	73	89	102
	1,600	6.9	5.9	14.2	16,498	870	16	30	43	55	65	74	90	104
8T	250	7.6	6.8	7.1	11,016	130	23	45	59	73	86	97	116	132
	600	7.6	6.8	6.1	10,404	487	18	34	48	60	72	82	100	115
	1,000	7.6	6.7	10.5	13,734	485	18	34	48	60	72	82	100	115
	1,600	7.7	6.7	16.6	20,622	622	18	34	48	61	72	83	101	116
8P	250	8.7	7.9	8.0	12,118	84	26	48	67	84	98	111	133	151
	600	8.7	7.9	10.0	11,444	323	21	39	55	69	82	94	114	131
	1,000	8.8	7.9	11.9	15,107	315	21	39	55	70	83	95	115	133
	1,600	8.9	7.9	18.8	22,684	406	21	39	56	70	84	96	116	134
10T	250	9.5	8.7	9.0	14,321	65	28	53	74	92	108	122	146	166
	1,000	9.5	8.6	11.2	13,525	250	22	42	60	75	89	102	125	143
	1,600	9.6	8.6	21.1	26,809	317	23	43	61	76	91	104	126	145
10P	600	10.7	9.9	12.5	14,566	173	25	48	68	85	101	116	141	162
	1,000	10.8	9.9	20.1	19,228	227	25	48	68	86	102	116	141	163
	1,600	11.0	9.9	28.3	28,871	523	27	51	72	91	108	123	149	171
12T	600	11.3	10.4	13.5	16,646	149	27	50	71	90	107	122	148	170
	1,000	11.5	10.4	26.8	21,974	463	28	53	75	95	112	128	156	179
	1,600	11.5	10.4	30.5	32,995	453	29	54	76	96	113	129	157	180
12P	250	12.7	11.8	14.7	16,646	104	30	57	80	101	120	137	167	192
	600	12.7	11.8	16.2	16,646	138	30	57	80	101	120	137	167	192
	1,000	12.9	11.8	29.2	21,974	325	32	60	85	107	127	144	175	201
	1,600	13.0	11.8	33.0	32,995	319	32	60	85	108	127	145	176	202
14T	250	12.5	11.6	13.6	13,525	111	29	55	78	99	117	134	163	188
	600	12.5	11.6	19.6	13,525	147	29	55	78	99	117	134	163	188
	1,000	12.6	11.5	27.4	17,854	347	31	59	83	105	124	141	171	197
	1,600	12.7	11.5	30.5	26,809	341	31	59	84	105	125	142	173	198
14P/16T	250	14.0	13.0	15.5	16,126	79	33	62	88	111	132	151	183	211
	600	14.1	13.0	28.5	16,126	249	35	66	93	117	138	158	192	220
	1,000	14.1	12.9	31.1	21,288	248	35	66	93	117	139	158	192	220
	1,600	14.3	12.9	38.6	31,964	356	38	72	101	126	149	170	205	234

Notes:

- Based on 0.030 in. slot size (collapse values contain no safety factor)
- Recommended hang weight is 50 percent of the calculated tensile strength
- Transmitting capacity in gpm./ft. of screen = open area x 0.31 @ 0.1 ft./sec.
 - Screens are available in up to 40 ft. lengths of continuously wrapped screen with no mid-weld
 - Technical information is available upon request for 316 stainless steel screens
 - P - pipe size, T - telescope
 - For application depths > 1,600 ft., contact Technical Support

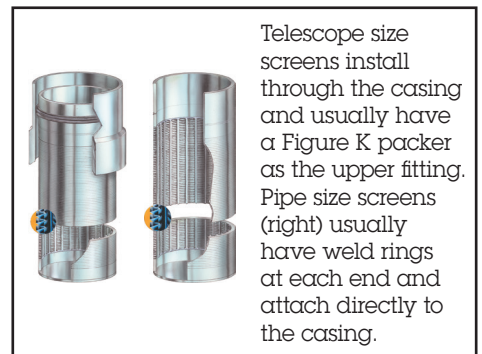

Large Diameter Free-Flow Screens: Sizes 16P - 36P

Size (in.)	Max Depth: (ft.)	OD: (in.)	ID: (in.)	Weight ¹ : (lbs./ft.)	Recom. Hang Weight ² : (lbs.)	Collapse Strength ¹ (PSI)	Intake Area ³ - sq in./ft of Screen							
							Screen Slot Size (thousandths of an in.)							
							10	20	30	40	50	60	80	100
16P/18T	100	16.0	15.1	17.7	18,207	52	38	71	101	127	151	173	210	242
	250	16.0	15.1	25.4	18,207	69	38	71	101	127	151	173	210	242
	600	16.2	15.1	32.6	18,207	166	40	75	106	134	159	181	220	252
	1,000	16.0	14.8	35.2	24,035	170	40	75	105	133	157	179	218	250
	1,600	16.2	14.8	43.6	48,510	166	40	75	106	134	159	181	220	252
18P/20T	100	17.8	16.8	19.2	18,727	38	42	79	112	141	168	192	233	268
	600	17.9	16.8	35.7	18,727	122	44	83	118	148	176	201	243	279
	1,000	18.0	16.7	43.0	37,120	120	45	84	118	149	177	202	245	281
	1,600	18.1	16.7	47.3	49,896	119	45	84	119	150	178	203	246	282
20P	100	19.9	18.8	21.7	21,848	28	47	88	125	158	187	214	260	299
	600	20.0	18.8	40.0	21,848	88	50	93	131	166	196	224	272	311
	1,000	20.1	18.7	54.0	43,306	127	54	101	142	179	211	240	289	330
	1,600	20.3	18.7	65.6	58,212	190	38	53	104	133	159	184	227	264
24T	100	21.8	20.7	34.6	24,970	28	51	97	137	173	205	235	286	329
	250	21.9	20.7	44.2	24,970	67	54	102	144	182	215	245	298	341
	600	22.0	20.6	54.2	32,962	98	59	111	155	195	230	262	316	360
	1,000	22.2	20.6	67.0	49,493	146	42	80	114	145	174	201	248	288
	1,600	22.4	20.6	72.8	66,528	145	42	80	114	146	175	201	248	289
24P/26T	250	24.1	22.8	46.8	20,808	50	60	112	159	200	237	270	327	376
	600	24.3	22.8	64.6	27,468	111	46	87	125	159	191	220	271	316
	1,000	24.4	22.8	69.3	41,244	110	46	87	125	160	191	220	272	317
	1,600	24.4	22.8	74.2	55,440	109	46	88	126	160	192	221	273	318
26P	250	25.7	24.4	49.9	22,369	42	64	120	169	213	252	288	349	400
	600	25.9	24.4	69.0	29,528	92	49	93	133	170	203	234	289	337
	1,000	26.0	24.4	74.1	44,337	91	49	93	134	170	204	235	290	338
	1,600	26.0	24.4	79.2	59,598	90	49	94	134	171	205	236	291	339
30T	250	27.0	25.7	52.2	22,369	36	67	126	178	224	265	303	367	421
	600	27.2	25.7	72.1	29,528	60	51	98	140	179	214	247	304	354
	1,000	27.3	25.7	77.1	44,337	78	52	98	140	179	215	247	305	355
	1,600	27.4	25.7	82.3	59,598	78	52	98	141	180	215	248	306	356
30P/36T	250	29.6	28.3	57.6	26,010	27	73	138	195	245	290	331	402	461
	600	29.8	28.3	79.5	34,335	60	56	107	153	195	234	270	333	387
	1,000	29.9	28.3	85.4	51,555	60	56	107	154	196	235	270	334	388
	1,600	29.9	28.3	91.4	69,300	59	56	108	154	196	235	271	335	389
36P	100	35.6	34.3	78.6	30,172	23	96	179	252	316	373	424	512	584
	250	35.7	34.3	90.0	30,172	35	67	128	184	234	281	323	399	465
	600	35.9	34.3	108.2	39,829	53	68	129	185	235	282	325	401	467

Notes:

1. Based on 0.030 in. slot size (collapse values contain no safety factor)
2. Recommended hang weight is 50 percent of the calculated tensile strength
3. Transmitting capacity in gpm./ft. of screen = open area x 0.31 @ 0.1 ft./sec.

- Screens are available in up to 40 ft. lengths of continuously wrapped screen with no mid-weld
- Technical information is available upon request for 316 stainless steel screens
- P - pipe size, T - telescope
- For application depths > 1,600 ft., contact Technical Support

Hi-Flow™ 304 Stainless Steel Screens

Large Diameter Hi-Flow Screens: Sizes 6P - 16T

Size (in.)	Max Depth (ft.)	OD (in.)	ID (in.)	Weight ¹ (lbs./ft.)	Recom. Hang Weight ² (lbs.)	Collapse Strength ¹ (PSI)	Intake Area ³ - sq in./ft. of Screen							
							Screen Slot Size (thousandths of an in.)							
							10	20	30	40	50	60	80	100
6P	100	6.6	6.1	4.5	4,315	83	36	62	83	100	113	124	142	156
	250	6.7	6.1	6.4	4,315	244	25	46	63	78	90	101	119	133
	600	6.7	5.9	7.5	8,813	242	25	46	64	78	91	102	119	133
	1,000	6.8	5.9	9.1	8,813	500	31	56	76	92	105	117	135	149
	1,600	6.8	5.9	12.8	16,498	564	20	38	53	66	77	87	105	119
8T	100	7.5	6.8	6.6	11,016	58	40	70	94	113	128	141	161	176
	600	7.5	6.8	8.8	11,016	169	29	52	72	88	102	114	135	150
	1,000	7.5	6.7	12.7	13,734	415	23	42	58	73	86	97	116	132
	1,600	7.6	6.7	15.1	20,622	402	23	42	59	74	87	98	117	133
8P	250	8.7	7.9	10.0	12,118	112	33	60	82	101	117	131	155	173
	600	8.7	7.9	11.9	12,118	233	41	72	98	119	136	151	174	192
	1,000	8.8	7.9	19.0	15,107	636	24	44	62	78	93	105	127	145
	1,600	8.9	7.9	21.6	22,684	619	24	45	63	79	93	106	128	146
10T	250	9.5	8.7	11.2	14,321	85	36	66	90	111	129	144	169	189
	600	9.5	8.7	13.3	14,321	179	44	79	107	130	149	165	191	211
	1,000	9.6	8.6	21.1	17,854	496	26	48	68	85	101	114	138	158
	1,600	9.7	8.6	24.2	26,809	484	26	49	68	86	101	115	139	159
10P	250	10.8	9.9	14.8	15,422	125	50	89	120	146	168	186	215	237
	600	10.8	9.9	21.1	14,566	351	29	54	76	96	113	129	155	177
	1,000	10.8	9.9	23.5	19,228	346	29	54	77	96	114	129	156	178
	1,600	10.9	9.9	26.8	28,871	339	29	55	77	97	114	130	157	179
12T	250	11.3	10.4	16.0	17,626	107	53	94	127	154	176	195	226	250
	600	11.4	10.4	22.5	16,646	302	31	57	80	101	119	135	163	186
	1,000	11.4	10.4	25.2	21,974	300	31	57	80	101	119	135	163	187
	1,600	11.5	10.4	29.0	32,995	294	31	58	81	102	120	136	165	188
12P	250	12.8	11.8	17.4	17,626	75	59	106	143	173	199	220	255	281
	600	12.8	11.8	24.8	16,646	211	34	64	90	114	134	152	184	210
	1,000	12.8	11.8	27.5	21,974	210	35	64	91	114	134	153	184	210
	1,600	12.9	11.8	31.3	32,995	206	35	65	91	114	135	154	185	211
14T	250	12.5	11.6	16.2	14,321	80	58	103	140	170	194	215	249	275
	600	12.5	11.6	23.5	13,525	226	34	63	88	111	131	149	180	205
	1,000	12.5	11.5	25.7	17,854	224	34	63	89	111	131	149	180	206
	1,600	12.6	11.5	28.8	26,809	220	34	63	89	112	132	150	181	207
14P/16T	250	14.0	13.0	18.5	17,075	57	65	116	157	190	218	242	279	308
	600	14.0	13.0	26.6	16,126	161	38	71	99	124	147	167	201	230
	1,000	14.0	13.0	29.2	21,288	160	38	71	99	125	147	167	202	230
	1,600	14.1	13.0	32.9	31,964	157	38	71	100	125	148	168	203	231

Notes:

1. Based on 0.030 in. slot size (collapse values contain no safety factor)
2. Recommended hang weight is 50 percent of the calculated tensile strength
3. Transmitting capacity in gpm./ft. of screen = open area x 0.31 @ 0.1 ft./sec.

- Screens are available in up to 40 ft. lengths of continuously wrapped screen with no mid-weld
- Technical information is available upon request for 316 stainless steel screens
- P - pipe size, T - telescope
- For application depths > 1,600 ft., contact Technical Support

Large Diameter Hi-Flow Screens: Sizes 16P - 36P

Size (in.)	Max Depth: (ft.)	OD: (in.)	ID: (in.)	Weight ¹ : (lbs./ft.)	Recom. Hang Weight ² : (lbs.)	Collapse Strength ¹ (PSI)	Intake Area ³ - sq in./ft of Screen							
							Screen Slot Size (thousandths of an in.)							
							10	20	30	40	50	60	80	100
16P/18T	100	16.1	15.1	21.1	19,278	38	75	133	180	218	250	277	321	354
	600	16.1	15.1	30.4	18,207	107	43	81	114	143	169	192	231	264
	1,000	16.0	14.8	35.2	24,035	170	40	75	105	133	157	179	218	250
	1,600	16.2	14.8	43.6	48,510	166	40	75	106	134	159	181	220	252
18P/20T	600	17.8	16.8	33.3	18,727	78	48	90	126	158	187	212	212	292
	1,000	18.0	16.7	43.0	37,120	120	45	84	118	149	177	202	245	281
	1,600	18.1	16.7	47.3	49,896	119	45	84	119	150	178	203	249	282
20P	250	19.9	18.8	37.5	21,848	56	54	100	141	177	208	237	286	326
	600	20.0	18.8	40.0	21,848	88	50	93	131	166	196	224	272	311
	1,000	20.1	18.7	54.0	43,306	127	54	101	142	179	211	240	289	330
	1,600	20.2	18.7	59.1	58,212	126	54	102	143	179	212	240	290	331
24T	250	21.8	20.7	41.4	24,970	43	59	110	154	194	229	260	314	358
	600	22.0	20.6	54.2	32,962	98	59	111	155	195	230	262	316	360
	1,000	22.2	20.6	67.0	49,493	146	42	80	114	145	174	201	248	288
	1,600	22.2	20.6	72.8	66,528	145	42	80	114	146	175	201	248	289
24P/26T	100	24.0	22.8	43.7	20,808	32	65	121	170	213	252	286	345	394
	250	24.1	22.8	46.8	20,808	50	60	112	159	200	237	270	327	376
	600	24.3	22.8	64.6	27,468	111	46	87	125	159	191	220	271	316
	1,000	24.4	22.8	69.3	41,244	110	46	87	125	160	191	220	272	317
	1,600	24.4	22.8	74.2	55,440	109	46	88	126	160	192	221	273	318
26P	100	25.6	24.4	46.7	22,369	27	69	129	181	227	268	305	368	420
	250	25.7	24.4	49.9	22,369	42	64	120	169	213	252	288	349	400
	600	25.9	24.4	69.0	29,528	92	49	93	133	170	203	234	289	337
	1,000	26.0	24.4	74.1	44,337	91	49	93	134	170	204	235	290	338
	1,600	26.0	24.4	79.2	59,598	90	49	94	134	171	205	236	291	339
30T	100	27.0	25.7	48.8	22,369	23	73	136	191	239	282	321	387	442
	250	27.0	25.7	52.2	22,369	36	67	126	178	224	265	303	367	421
	600	27.2	25.7	72.1	29,528	79	51	98	140	179	214	247	304	354
	1,000	27.3	25.7	77.1	44,337	78	52	98	140	179	215	247	305	355
	1,600	27.4	25.7	82.3	59,598	78	52	98	141	180	215	248	306	356
30P/36T	100	29.5	28.3	53.8	26,010	17	79	148	209	262	309	351	424	484
	250	29.6	28.3	57.6	26,010	27	73	138	195	245	291	331	402	461
	600	29.8	28.3	79.5	34,335	60	56	107	153	195	234	270	333	387
	1,000	29.9	28.3	84.5	51,555	60	56	107	154	196	235	270	334	388
	1,600	29.9	28.3	91.4	69,300	59	56	108	154	196	235	271	335	389
36P	250	35.6	34.3	78.6	30,172	23	96	179	252	316	373	424	512	584
	600	35.9	34.3	108.2	398,929	44	68	129	185	235	282	325	401	467

Notes:

1. Based on 0.030 in. slot size (collapse values contain no safety factor)
2. Recommended hang weight is 50 percent of the calculated tensile strength
3. Transmitting capacity in gpm/ft of screen = open area x 0.31 @ 0.1 ft./sec.

- Screens are available in up to 40 ft. lengths of continuously wrapped screen with no mid-weld
- Technical information is available upon request for 316 stainless steel screens
- P - pipe size, T - telescope
- For application depths > 1,600 ft., contact Technical Support

HiCap™ High Capacity Low Carbon Steel Screens

Large Diameter HiCap Screens: Sizes 6P -18T

Size (in.)	Max Depth (ft.)	OD (in.)	ID (in.)	Weight ¹ (lbs./ft.)	Recom. Hang Weight ² : (lbs.)	Collapse Strength ¹ (PSI)	Intake Area ³ - sq in./ft. of Screen					
							Screen Slot Size (thousandths of an in.)					
							30	40	50	60	80	100
6 P	250	6.6	6.0	6.3	5,100	266	63	77	90	100	118	132
	1,000	6.9	5.9	15.5	14,500	1,855	30	39	47	54	67	79
8 T	250	7.5	6.7	8.7	12,900	182	71	88	102	114	134	150
	1,000	7.7	6.7	17.9	18,100	1,340	34	43	52	60	75	88
8 P	250	8.7	7.9	9.9	14,100	117	83	102	118	132	155	174
	1,000	8.9	7.9	20.3	19,900	871	39	50	60	70	87	102
10 T	250	9.5	8.6	11.1	16,700	90	90	111	129	144	170	189
	1,000	9.7	8.6	22.6	23,600	674	42	54	66	76	95	111
10 P	250	10.9	9.8	25.2	25,400	476	48	61	74	85	106	125
	600	10.9	9.8	25.2	25,400	476	48	61	74	85	106	125
	1,000	10.9	9.8	25.2	25,400	476	48	61	74	85	106	125
12 T	250	11.4	10.6	27.1	29,000	476	48	61	74	85	106	125
	600	11.4	10.6	27.1	29,000	476	48	61	74	85	106	125
	1,000	11.4	10.6	27.1	29,000	476	48	61	74	85	106	125
12 P	250	12.9	11.8	29.5	29,000	288	56	72	87	101	126	148
	600	12.9	11.8	31.2	29,000	333	68	86	103	119	147	171
	1,000	13.0	11.8	34.3	29,000	502	60	76	92	106	132	155
14 T	250	12.6	11.5	27.5	23,600	309	55	71	85	99	123	144
	600	12.6	11.5	27.5	23,600	309	55	71	85	99	123	144
	1,000	12.6	11.5	29.1	23,600	357	66	84	101	116	143	167
14 P/ 16 T	250	14.1	13.0	31.3	28,100	221	62	79	95	110	138	162
	600	14.1	13.0	31.3	28,100	221	62	79	95	110	138	162
	1,000	14.1	13.0	33.1	28,100	255	74	94	113	130	160	187
16 P/ 18 T	250	16.0	14.8	35.5	31,700	152	70	90	108	125	156	183
	600	16.0	14.8	35.5	31,700	152	70	90	108	125	156	183
	1,000	16.0	14.8	37.7	31,700	175	84	107	128	148	182	212

1. Based on 0.030 in. slot size (collapse values contain no safety factor)
2. Recommended hang weight is 50 percent of the calculated tensile strength
3. Transmitting screen = open area x 0.31 at 0.1 ft./sec.

Notes:

- Screens are available in up to 40 ft. lengths of continuously wrapped screen with no mid-weld
- Technical information is available upon request for 316 stainless steel screens
- P - pipe size, T - telescope
- For application depths > 1,000 ft., contact Technical Support

Large Diameter HiCap Screens: Sizes 18P - 36P

Size (in.)	Max Depth: (ft.)	OD (in.)	ID (in.)	Weight ¹ : (lbs/ft.)	Recom. Hang Weight ² (lbs)	Collapse Strength ¹ (PSI)	Intake Area ³ - sq. in./ft. of Screen					
							Screen Slot Size (thousandths of an in.)					
							30	40	50	60	80	100
18 P/ 20 T	250	17.9	16.7	39.0	32,600	108	78	100	121	140	175	205
	600	17.9	16.7	41.5	32,600	125	94	120	144	165	204	237
	1,000	18.0	16.7	46.1	32,600	190	82	106	127	147	183	214
20 P	250	20.0	18.8	44.0	38,100	78	87	112	135	157	195	229
	600	20.0	18.8	46.7	38,100	90	105	134	160	185	228	265
	1,000	20.1	18.8	51.9	38,100	137	92	118	142	164	204	239
24 T	250	21.9	20.7	48.7	43,500	59	96	123	148	171	214	251
	600	21.9	20.7	51.7	43,500	68	115	147	176	202	249	290
	1,000	22.0	20.7	57.4	43,500	104	101	129	155	180	223	262
24 P/ 26 T	100	24.2	22.8	53.8	48,100	44	106	136	163	189	236	277
	250	24.2	22.8	57.1	48,100	51	127	162	194	223	275	320
	600	24.3	22.8	63.2	48,100	78	111	143	172	198	247	289
	1,000	24.4	22.8	74.6	48,100	124	149	189	224	257	313	361
26 P	100	25.8	24.4	57.5	51,700	36	113	145	174	202	252	296
	250	25.8	24.4	61.0	51,700	42	136	173	207	238	294	341
	600	25.9	24.4	67.6	51,700	64	119	152	183	211	263	308
	1,000	26.0	24.4	79.7	51,700	102	159	201	239	274	334	384
30 T	100	27.1	25.8	59.8	51,700	31	118	152	183	212	265	311
	250	27.1	25.8	63.5	51,700	36	143	182	217	250	308	358
	600	27.2	25.8	70.3	51,700	55	125	160	192	222	276	323
	1,000	27.3	25.8	83.1	51,700	88	167	211	251	287	350	404
30 P/ 36 T	250	29.7	28.3	70.4	60,100	28	156	199	238	274	338	393
600	29.9	28.3	91.6	60,100	67	183	211	275	315	384	442	
36 P	100	100	35.7	34.3	69,800	83.9	16	188	239	286	406	472
	250	250	35.8	34.3	69,800	92.9	24	164	210	292	364	426
	600	600	35.9	34.3	69,800	109.3	39	219	278	378	461	531

1. Based on 0.030 in. slot size (collapse values contain no safety factor)
2. Recommended hang weight is 50 percent of the calculated tensile strength
3. Transmitting capacity in gpm/ft. of screen = open area x 0.31 at 0.1 ft./sec.

Notes:

- Screens are available in up to 40 ft. lengths of continuously wrapped screen with no mid-weld
- Technical information is available upon request for 316 stainless steel screens
- P - pipe size, T - telescope
- For application depths > 1,000 ft., contact Technical Support

Hicap™ High Capacity

Low Carbon Steel Galvanized Screens

Large Diameter HiCap Screens: sizes 6P - 16T

Size (in.)	Max Depth (ft.)	OD (in.)	ID (in.)	Weight ¹ (lbs/ft.)	Recom. Hang Weight ² (lbs.)	Collapse Strength ¹ (PSI)	Intake Area ³ - sq in./ft. of Screen							
							Screen Slot Size (thousandths of an in.)							
							10	20	30	40	50	60	80	100
6 P	250	6.6	6.0	6.3	5,100	266	25	46	63	77	90	100	118	132
	1,000	6.6	5.9	7.9	9,600	266	25	46	63	77	90	100	118	132
8 T	600	7.5	6.7	9.2	12,100	182	29	52	71	88	102	114	134	150
	1,000	7.7	6.7	16.6	24,100	573	19	37	52	65	77	88	106	121
8 P	250	8.6	7.9	10.4	13,300	121	33	59	82	101	117	131	153	172
	600	8.7	7.9	14.9	13,300	399	22	41	58	73	87	99	120	137
	1,000	8.8	7.9	18.8	26,500	385	22	42	59	74	88	100	121	139
10 T	250	9.3	8.6	11.7	19,000	96	35	64	88	109	126	141	166	186
	600	9.5	8.6	16.6	15,700	307	24	45	64	80	95	108	131	150
	1,000	9.6	8.6	21.1	31,300	297	24	46	64	81	96	109	132	151
10 P	100	10.6	9.8	13.0	16,800	65	40	73	101	124	144	161	189	211
	600	10.7	9.8	18.5	16,800	215	27	51	72	90	107	122	147	169
	1,000	10.8	9.8	23.3	33,600	209	27	51	72	91	108	123	149	170
12 T	100	11.2	10.4	14.1	19,300	55	43	77	106	131	152	170	200	223
	600	11.2	10.4	14.1	19,300	55	43	77	106	131	152	170	200	223
	1,000	11.4	10.4	25.4	38,500	178	29	54	76	96	114	130	157	180
12 P	100	12.6	11.8	15.2	19,300	39	48	87	120	147	171	191	225	251
	600	12.7	11.8	21.7	19,300	129	32	60	85	107	127	144	175	200
	1,000	12.8	11.8	27.2	38,500	126	32	61	86	108	128	145	176	202
14 T	100	12.3	11.6	14.0	15,700	42	47	85	117	144	167	187	220	245
	600	12.5	11.6	20.3	15,700	135	32	59	84	105	125	142	172	197
	1,000	12.7	11.6	31.7	31,300	348	25	47	67	85	102	117	145	168
14	250	14.0	13.1	23.1	18,700	96	35	66	94	118	140	159	193	221
P/	600	14.1	13.1	30.6	18,700	255	27	52	74	94	113	130	160	187
16 T	1,000	14.2	13.0	36.1	37,300	250	27	52	75	95	114	131	162	188

1. Based on 0.030 in. slot size (collapse values contain no safety factor)
2. Recommended hang weight is 50 percent of the calculated tensile strength
3. Transmitting capacity in gpm/ft. of screen = open area x 0.31 at 0.1 ft./sec.

Notes:

- Screens are available in up to 40 ft. lengths of continuously wrapped screen with no mid-weld
- Technical information is available upon request for 316 stainless steel screens
- P - pipe size, T - telescope
- For application depths > 1,000 ft., contact Technical Support

Large Diameter HiCap Screens: Sizes 16P - 36P

Size (in.)	Max Depth (ft.)	OD (in.)	ID (in.)	Weight ¹ (lbs./ft.)	Recom. Hang Weight ² (lbs.)	Collapse Strength ¹ (PSI)	Intake Area ³ - sq. in./ft of Screen							
							Screen Slot Size (thousandths of an in.)							
							10	20	30	40	50	60	80	100
16 P/ 18 T	250	16.0	15.0	26.4	21,100	65	40	76	107	135	160	182	220	252
	600	16.2	15.0	35.1	21,100	169	31	60	85	109	130	150	184	214
	1,000	16.1	14.8	40.9	42,100	172	31	59	85	108	129	149	183	213
18 P/ 20 T	100	17.8	16.7	28.8	21,700	47	45	84	119	150	178	202	245	281
	600	17.9	16.7	35.1	21,700	125	35	66	94	120	144	165	204	237
	1,000	18.0	16.7	40.9	43,300	123	35	66	95	121	144	166	205	238
20 P	100	19.8	18.8	32.5	25,300	34	50	94	133	167	197	225	273	312
	600	20.0	18.8	43.1	25,300	90	39	74	105	134	160	185	228	265
24 T	100	21.8	20.7	35.9	28,900	26	55	103	146	184	217	248	300	344
	600	21.9	20.7	47.6	28,900	68	42	81	155	147	176	202	249	290
24 P/ 26 T	250	24.2	22.8	57.1	48,100	51	47	89	127	162	194	223	275	320
26 P	250	25.8	24.4	61.0	51,700	42	50	100	143	173	207	238	294	341
30 T	250	27.2	25.8	63.5	51,700	36	52	100	143	182	217	250	308	358
30 P/ 36 T	250	29.7	28.3	70.4	60,100	28	57	109	156	199	238	274	338	393

1. Based on 0.030 in. slot size (collapse values contain no safety factor)

2. Recommended hang weight is 50 percent of the calculated tensile strength

3. Transmitting capacity in gpm/ft. of screen = open area x 0.31 @ 0.1 ft./sec.

Notes:

- Screens are available in up to 40 ft. lengths of continuously wrapped screen with no mid-weld
- Technical information is available upon request for 316 stainless steel screens
- P - pipe size, T - telescope
- For application depths > 1,000 ft., contact Technical Support

Muni-Pak™ Pre-Packed Well Screens

Muni-Pak screens are pre-packed, providing numerous features and advantages for the contractor and well owner. A smaller borehole, stronger construction, thinner filter pack and maximized open area all combine for an energy and time saving well screen.

Size ¹ (in.)	Approx. Screen ID (in.)	Approx. Screen OD (in.)	Media Annular Thick- ness (in.)	Inner Screen Open Area - sq. in./ft. of Screen								Outer Screen Open Area - sq. in./ft. of Screen								Approx. Screen Weight (lbs/ft.)
				Screen Slot Size (thousandths of an in.)								Screen Slot Size (thousandths of an in.)								
				10	20	30	40	50	60	80	100	10	20	30	40	50	60	80	100	
2 x 4	1.5	4.5	0.85	13	22	30	35	40	44	51	55	24	42	56	68	77	85	97	106	17
3 x 5	2.8	5.7	0.97	20	35	46	55	63	69	79	86	30	53	70	84	96	105	120	132	23
4 x 6	3.8	6.7	0.94	25	44	59	70	80	87	100	110	36	62	83	100	114	125	143	156	25
5 x 7	4.7	7.7	0.87	30	53	70	84	96	105	120	132	40	70	94	113	128	141	161	176	27
6 x 8	5.8	8.7	0.84	36	62	83	100	114	125	143	156	46	81	108	129	147	162	185	202	35
8 x 10	7.7	10.8	0.84	33	60	82	101	117	131	155	172	41	74	102	125	145	162	191	213	55
10 x 12	9.8	12.8	0.84	41	74	102	125	145	162	191	213	48	88	121	148	172	193	226	253	70
12 x 15	11.8	15.0	0.84	59	106	143	173	199	220	255	281	69	122	165	200	230	255	295	325	85
14 x 16	13.0	16.0	0.64	42	78	108	135	159	180	215	244	48	89	125	155	183	207	247	281	100
16 x 18	15.0	18.0	0.64	48	89	125	155	183	207	247	281	54	99	139	173	204	230	276	313	115
18 x 20	16.9	20.0	0.78	54	99	139	173	204	230	276	313	59	110	154	192	226	256	306	347	128

Muni-Pak Screen vs. Standard Rod Based Screen

Nominal Size (in.) ²		Collapse Strength (PSI)		Tensile Strength (PSI)	
Rod Based	Muni-Pak	Rod Based	Muni-Pak	Rod Based	Muni-Pak
2	2 x 4	1,940	16,500	4,300	12,500
3	3 x 5	540	5,650	5,200	15,000
4	4 x 6	730	2,830	6,100	18,800
5	5 x 7	440	1,550	7,000	20,700
6	6 x 8	260	990	17,600	41,600
8	8 x 10	250	1,160	24,200	50,000
10	10 x 12	360	630	30,800	81,400
12	12 x 15	220	880	35,200	87,000
14	14 x 16	170	1,110	35,200	95,400
16	16 x 18	170	760	72,200	135,900
18	18 x 20	130	540	74,200	147,200

1. Other sizes available upon request
2. Values compare 1,000 ft. construction Muni-Pak to 1,000 ft. construction rod base



Standard Glass Filter Pack Sizes

Screen Slot Size (Thousandths of an in.)	Bead Diameter (in.)	Bulk Density (lb. ft. ³)
10	0.016 - 0.024	93.0
20	0.030-0.0390	93.0
30	0.039 - 0.051	94.3
40	0.049 - 0.065	94.3
50	0.061 - 0.073	94.9
60	0.079 - 0.094	95.5
80	0.094 - 0.114	95.5
100	0.112 - 0.136	95.5



Pipe Based Well Screens

Pipe based well screens combine the hydraulic efficiency of wire-wound screens with the strength of pipe. Because of the strength of the pipe liner, the wrap wires can be smaller, producing a greater open area.

The longitudinal support rods on the screen jacket create channels, which direct incoming flow to the nearest pipe perforation. Screen and pipe are welded to make a rugged, reliable unit suitable for deep vertical wells and supply wells.

Stainless Steel Pipe Based Well Screens

Size (in.)	Pipe OD (in.)	Pipe Open Area Per ft./sq. (in ²)	Screen OD (in.)	Approx. Weight (lbs.)	Open Area - sq. in./ft. of Screen				
					Screen Slot Size (thousandths of an in.)				
					10	15	20	25	30
1.5	1.90	7.95	2.33	4	9.0	13.0	16.0	19.0	22.0
2.0	2.38	9.28	2.81	5	11.0	15.0	19.0	23.0	27.0
2.5	2.88	10.60	3.68	7	12.0	18.0	23.0	27.0	31.0
3.0	3.50	11.93	3.94	10	15.0	21.0	27.0	33.0	37.0
4.0	4.50	28.27	4.96	14	19.0	27.0	34.0	41.0	47.0
5.0	5.56	35.34	5.96	17	23.0	32.0	41.0	49.0	57.0
6.0	6.63	40.06	7.11	24	27.0	38.0	49.0	59.0	68.0
7.0	7.00	37.70	7.48	35	28.0	41.0	52.0	62.0	71.0
7.625	7.63	42.41	8.12	44	31.0	44.0	56.0	67.0	77.0
8	8.63	49.48	9.48	38	36.0	52.0	66.0	78.0	90.0
9.625	9.63	49.48	10.24	41	39.0	56.0	71.0	88.0	97.0
10.0	10.75	56.55	11.30	49	43.0	61.0	78.0	93.0	107.0
12.0	12.75	65.97	12.41	60	51.0	73.0	93.0	111.0	127.0
14.0	14.00	70.69	14.70	69	56.0	80.0	102.0	121.0	140.0
16.0	16.00	75.40	16.73	78	64.0	91.0	116.0	138.0	159.0

Notes:

Weight is based on standard wall pipe, except for 7.625 in.



Pipe Based Well Screen

304 Stainless Steel Casings

Pipe Size Nom. Diam. (in.)	Sch.	OD (in.)	ID (in.)	Weight Per ft.	Collapse Strength (PSI)
1.0	5		1.185	0.88	
	10	1.315	1.097	1.42	2,445
	40		1.049	1.70	
1.25	5		1.530	1.12	1,362
	10	1.660	1.442	1.82	3,271
	40		1.380	2.29	4,736
1.5	5		1.770	1.29	1,074
	10	1.900	1.682	2.10	2,704
	40		1.610	2.74	4,177
2.0	5		2.245	1.62	650
	10	2.375	2.157	2.66	1,824
	40		2.067	3.69	3,208
3.0	5		3.334	3.06	468
	10	3.500	3.260	4.37	1,050
	40		3.068	7.65	2,972
4.0	5		4.334	3.95	253
	10	4.500	4.260	5.67	614
	40		4.026	10.90	2,303
5.0	5		5.345	6.41	295
	10	5.563	5.295	7.84	486
	40		5.047	14.75	1,854
6.0	5		6.407	7.66	189
	10	6.625	6.357	9.38	319
	40		6.065	19.15	1,570
8.0	10	8.625	8.329	13.53	210
	40		7.981	28.82	1,243
10.0	10	10.750	10.420	18.83	157
	40		10.020	40.86	1,030
12.0	10	12.750	12.390	24.39	126
	0.375*		12.000	50.03	762

* Standard wall



Sch. 40 Low Carbon Steel Casings

Pipe Size Nom. Diam. (in.)	OD (in.)	ID (in.)	Weight Per (ft.)	Collapse Strength (PSI)
1.0	1.315	1.049	1.68	6,127
1.25	1.660	1,380	2.27	4,743
1.5	1.900	1,610	2.72	4,185
2.0	2.375	2.067	3.65	3,219
3.0	3.500	3.068	7.58	2,983
4.0	4.500	4.026	10.79	2,316
5.0	5.563	5.047	14.62	1,869
6.0	6.625	6.065	18.97	1,585
8.0	8.625	7.981	28.55	1,259
10.0	10.750	10.020	40.48	1,045
12.0*	12.750	12.000	49.56	776

* Standard wall



Specifications

Well Screens

General: Well screens shall be of the continuous slot design to provide maximum open area, to reduce entrance velocity, increase hydraulic efficiency and promote more effective development. The well screens shall be constructed of Vee-Wire® trapezoidal wire, continuously wrapped around an array of equally spaced support rods of the same material. Each junction of wire/rod contact shall be resistance welded. The screens and end fittings shall be made of _____ (material). The well screens shall be the Johnson Screens product brand, or an approved equal.

Collapse strength: Well screens shall be _____ inches OD, continuous slot wire-wrapped _____ (material), designed to withstand a minimum collapse pressure of _____ psi for a _____ inch slot opening. The surface wire shape shall cause the slot opening to widen inwardly to minimize clogging. Surface wrap-wire height shall be _____ inches to provide the desired collapse strength. The wrap-wire face width shall be of minimum dimensions to provide _____ percent open area at the anticipated _____ inch slot opening.

Tensile strength: The minimum screen tensile strength must exceed at least twice the total weight of the screen and any standard wall blank casing suspended below the top screen joint. The tensile strength shall be a minimum of _____ pounds. (Tensile strength is total rod area times material yield strength.)

Screen configuration: Screens shall be manufactured in various lengths complete with _____ (material) weld rings attached to each end. The weld rings shall be standard available lengths as requested by the contractor and approved by the engineer.

Screen Submittals

Upon request, the screen manufacturer shall provide a submittal and schematic drawing of the proposed screen design. The documents shall include the OD, ID, construction materials, slot size, approximate weight per foot, wrap-wire length, wrap-wire height, collapse strength, percent open area, inlet open area per foot, transmitting capacity per foot, number of support rods, diameter of support rods, total cross sectional rod area, material yield strength, tensile strength, column load and recommended hang weight.

Muni-Pak™ screens

General: Muni-Pak™ screens shall be of the continuous slot design to provide maximum open area, to reduce entrance velocity, increase hydraulic efficiency and promote more effective development. Both the inner and outer screens shall be constructed out of Vee-Wire trapezoidal wire, continuously wrapped around an array of equally spaced support rods of the same material. Each junction of wire/rod contact shall be resistance welded.

The screens and end fittings shall be made of _____ (material). The well screens shall be the Johnson Screens product brand, or an approved equal.

Diameter: The Muni-Pak screen shall be _____ inch pipe size inner screen by _____ inch pipe size outer screen.

Collapse: The dual screen assembly shall be manufactured with a wrap-wire designed to yield a minimum collapse pressure of _____ psi at a design slot opening of _____ inches. The wire shape shall cause the slot opening to widen inwardly to minimize clogging.

Open area: The inner screen shall provide _____ square inches of inlet area per foot of screen at the design slot size. The outer screen shall be of the same slot as the inner screen. The slot size and filter pack are to be selected on the basis of a sieve analysis of the water bearing formation.

Filter pack: The annulus between screens shall be filled with ceramic or glass beads of uniform size and excellent sphericity. The pack size shall be _____ filter size. The pack material shall be installed and compacted by vibrating the unit in a vertical position while being filled. The top and bottom filter seal plates shall be secured by welding.

Tensile strength: The minimum screen tensile strength must exceed at least twice the total hang weight of the screen and blank casing below the top screen joint. The tensile strength shall be a minimum of _____ pounds. (Tensile strength is total rod area times material yield strength.)

Screen configuration: Screens shall be manufactured in various lengths with a maximum of 40 feet length overall. Screens shall be complete with _____ (material) and fittings attached to each end. Standard weld rings are six inches long on each end. Weld rings of longer lengths, or threaded fittings may be requested. Screen barrels shall be provided in standard _____ (overall or full) lengths which _____ (include or exclude) the weld ring lengths. Lengths and end fitting configuration to be requested by the contractor and approved by the engineer.

Di-Electric Coupling

Di-Electric couplings prevent galvanic corrosion in municipal and industrial water well completions.

When two dissimilar metals are coupled in water-saturated environments, the less corrosion-resistant metal corrodes faster from the galvanic cell created. This corrosion can be prevented by eliminating the contact between the two metal surfaces.

A Di-Electric coupling uses non-conducting insulating ring material to isolate the metal surfaces and prevent electrical contact. This feature increases the life of the pipe and the life of the well.

Di-Electric couplings are available for pipe sizes from 1.5 - 24 in. Special sizes or connection adapters are available on request.

Features and Benefits

- In the center of the coupling, an insulating sleeve prevents dissimilar metals from making contact and causing corrosion of the casing. This feature extends the life of the pipe for long-term savings
- The coupling has a small OD, only 1.5 to 2 in. larger than the pipe. This feature saves costs by minimizing the size of the hole to be drilled
- The nominal ID of the string is maintained through the coupling for full design functionality

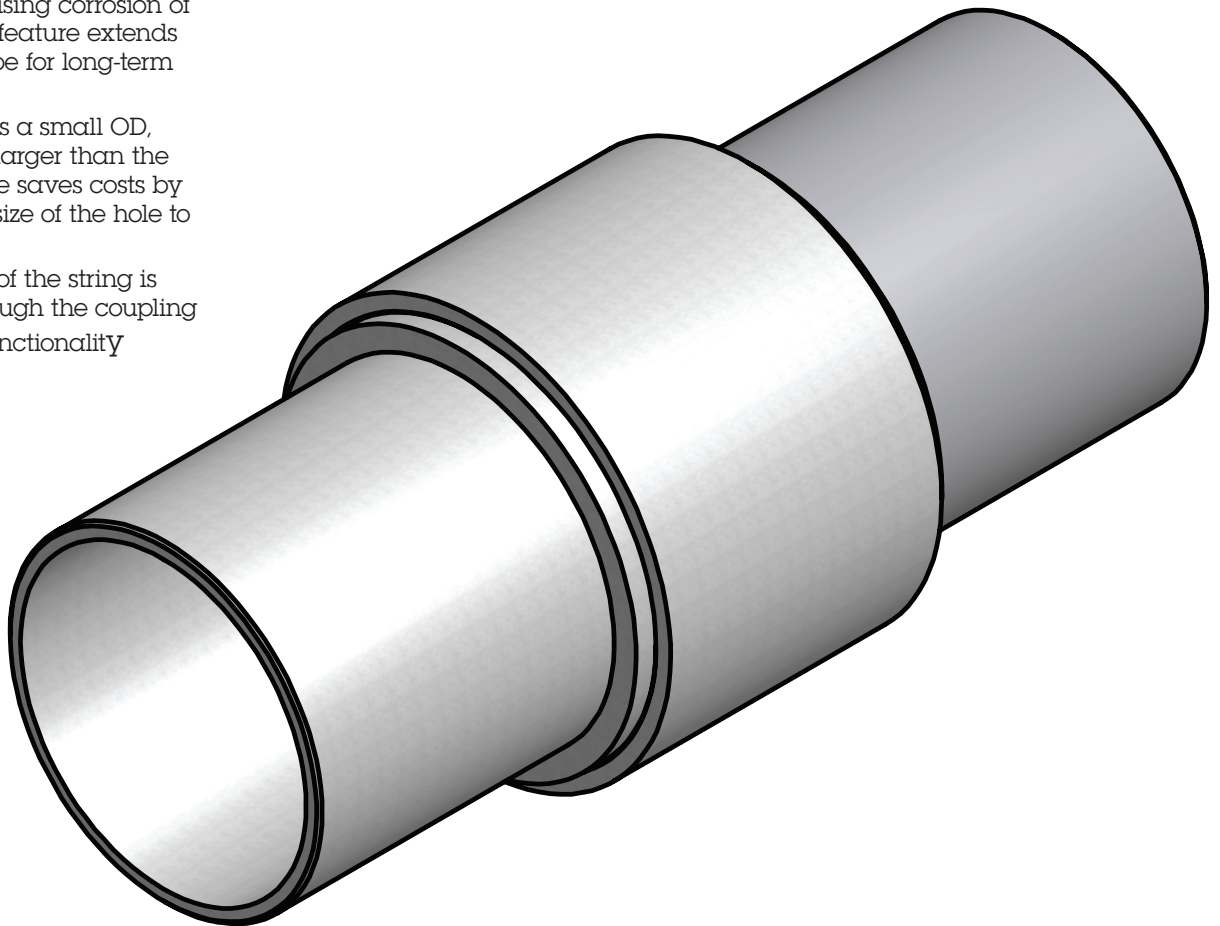

Central Utah Water Conservancy District (CUWCD) 24 in. Culinary Well



With a well depth just over 1,630 feet, the CUWCD required a screen with extreme tensile and collapse strength for the installation depth.

Using square rods, in lieu of the typical round rods, the design met the required needs.

When tested, tensile strength of the square rod screen design was over 200,000 lbs., well over the calculated string weight of 164,100 lbs.

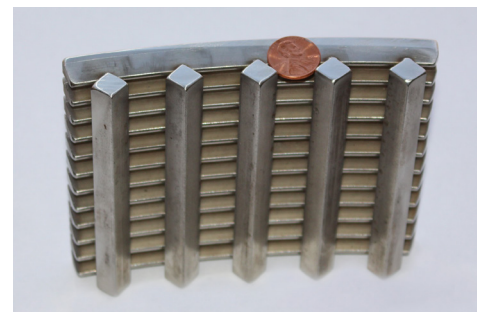

Sample of screen used for the installation



24 in. screen installed

Central Utah Water Conservancy District (CUWCD) 24 in. culinary well

Groundwater & Wells

Recognized worldwide by engineers, scientists and well drillers, *Groundwater & Wells*, Third Edition, is used as the authoritative text on hydrogeology, well hydraulics, design, construction and materials and is available for purchase at www.jswaterwell.com.

Groundwater and Wells, Third Edition, includes comprehensive coverage of the accepted practices in well management, and is a valuable tool for anyone who designs, specifies, drills, samples, manages, or interprets data from monitoring or recovery wells

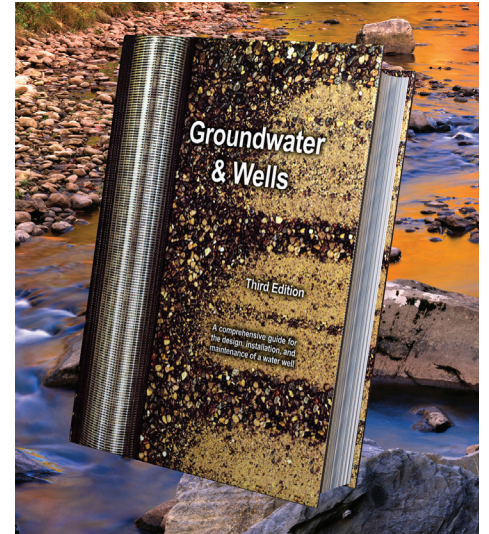

Chemical Cleaning, Disinfection & Decontamination of Water Wells

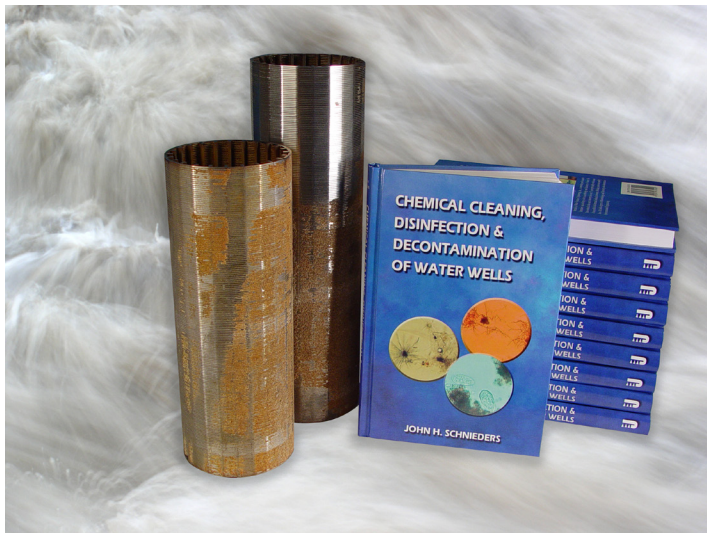

Chemical Cleaning, Disinfection & Decontamination of Water Wells book is a concise, complete assessment of the important role certain chemicals play in modern water treatment, water system construction and maintenance programs.

Included in this text are complete descriptions of chemicals frequently used in water supply applications. With a focus on effective and efficient use of chemicals, individually or in combination, to achieve better well rehabilitation, water system cleaning and water quality treatment.

Diagrams, formula mixer ratios and other technical data are included, along with proper handling techniques for each chemical and, where appropriate, clear warnings about possible hazards and the conditions that can cause them.

Chemical Cleaning, Disinfection & Decontamination of Water Wells book is in a convenient format for use on job sites, as well as classrooms and labs.

Johnson Screens Water Well Screens

North and South America
Phone +1 651 636 3900
info.us@johnsonscreens.com

Europe, Middle East & Africa
Phone +3 3 23 75 05 42
info.fr@johnsonscreens.com

Asia Pacific
Phone +61 7 3867 5555
info.au@johnsonscreens.com

johnsonscreens.com